



THE QUEEN'S AWARDS
FOR ENTERPRISE
PROUDLY 2017

ISOTECH



The Source for Calibration Professionals

The **microK** family of precision thermometry bridges

THE PROVEN CHOICE

- Models to suit both Primary and Secondary Laboratories -
- Documented Low Uncertainty Performance -
- Zero Drift Ratio Measurements -
- Fast Measurements -



The world's leading National Metrology
Institutes choose microK
...Shouldn't you?

www.isotech.co.uk

The microK Success Story

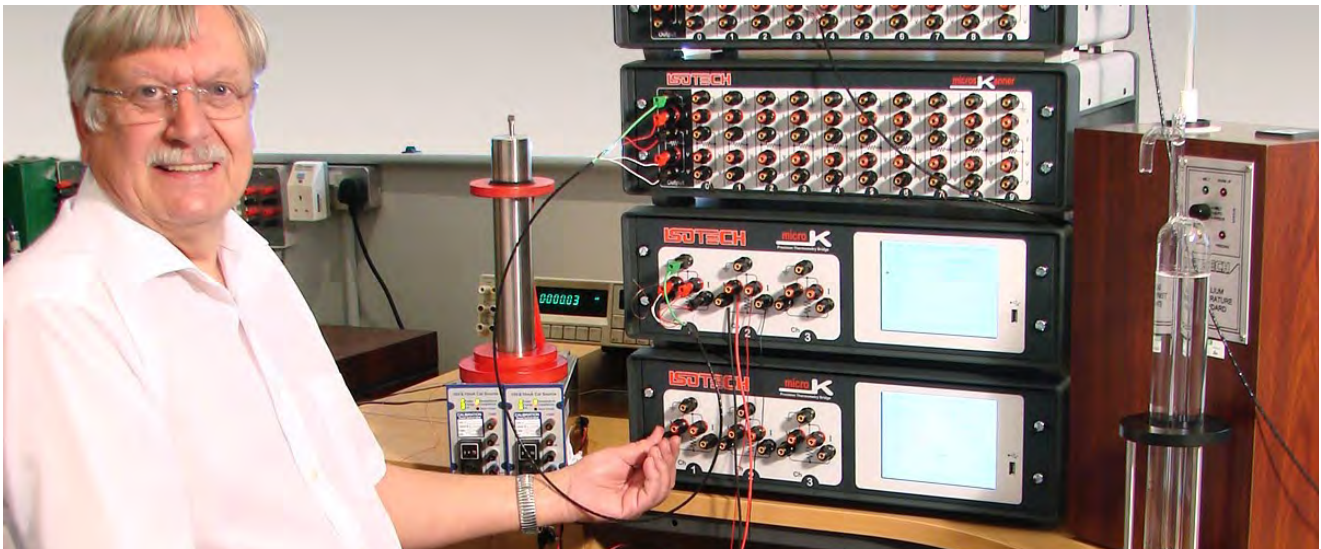

“ The ground-breaking innovation and outstanding commercial success of the microK lead to a Queen’s Award for Enterprise ...the highest honour that can be bestowed on a UK company ”



The microK was first launched in 2006 and quickly became established as the instrument of choice for high performance temperature calibration and measurement applications displacing older instruments. Today, the microK is widely used from NMIs offering the lowest uncertainties, to secondary laboratories and commercial ISO 17025 laboratories - it is even being used in mankind’s search for exoplanets at the Giant Magellan Telescope. The development and commercial success of the microK was recognised in 2017 with a Queen’s Award for Enterprise.

Performance

For a bridge, the key parameter is ratio accuracy - our stated values include linearity and stability. We specify conservatively so that the microK will always exceed expectations. Every microK is tested using a Resistance Bridge Calibrator so that it can be trusted to deliver its stated performance. In independent tests NMIs comparing different thermometry bridges have

found microK to have the best ratio accuracy.

Drift Free Ratio Measurements

Not only do we have ‘best in class performance’, the microK is unique in that it is drift free for ratio measurements. The microK uses a substitution topology in which the device under test and the reference resistor are alternately connected to the same point in the measurement circuit and then a ratio of these measurements is computed. This is in keeping with our “no compromise” philosophy, we consider this to be worthwhile since it offers unique drift free measurement with no need for adjustment, ever.

The microK has no hardware or software adjustments for ratio accuracy. The drift-free performance is one of the most exciting features of the microK.

When National Laboratories have tested the performance of older bridges from other manufacturers, not all have met claimed specifications or have shown to

have small but significant faults {1, 2}

Confidence

The number of NMIs using microK and the independent testing show that you can be confident choosing microK. If you need more assurance, then consider our microK GOLD, a microK with enhanced performance to <30ppb (whole range, 0 to unity) and an unmatched performance promise.

We guarantee the 30ppb performance and provide evidence by calibrating the microK with an Automatic Ratio Bridge Calibrator, A-RBC. What is more you can choose to return the bridge for performance validation of the ratio accuracy in year two and three.

No other company makes this commitment - we challenge you to find any other company to report ratio accuracy, measured with the RBC and who guarantee that for three years.

{1, 2} Performance Assessment of Resistance Ratio Bridges used for the Calibration of SPRTs
 Gregory F. Strouse and Kenneth D. Hill
 A Method for Calibrating Resistance Thermometry Bridges, D. R. White

microK Testing

Performance is verified with the Ratio Bridge Calibrator, developed by D. R. White at the National Laboratory in New Zealand. The RBC allows you to calibrate both AC and DC bridges to an accuracy of <math><10\text{ ppb}</math>. Isotech have the sole license to manufacture and supply the RBC.

The RBC has allowed both Isotech and leading NMIs to truly evaluate microK performance, it has given metrologists evidence of actual performance and contributed to the outstanding success of the microK bridge - **do not accept manufacturers claims for ratio accuracy - demand evidence.**



Automatic Resistance Bridge Calibrator

The microK Bridges are used not just for primary and secondary laboratories but for many other applications including pharmaceutical, power generation, oceanographic and space exploration.

Not Just for Primary Laboratories

microK GOLD, microK 70 and microK 125 are ideal for Primary Metrology applications, displacing older bridges models and offering both higher performance and significantly lower prices. They include parallel analogue processing to reduce voltage noise to unprecedented levels.

microK 250 and microK 500 are ideal for secondary laboratories, still offering performance better than 0.0005°C , 0.5 mK . Lower pricing allows more laboratories to benefit from the microK innovation and flexibility

microK

- Used by the World's Leading National Laboratories
- Proven Drift Free Ratio Measurement
- Supports SPRTs, IPRTs, Thermistors and Thermocouples



The microK Family

The microK family of precision thermometry bridges uses a completely new measurement technique to achieve accuracies to better than 0.02ppm.

The microK family includes models to suit all levels of temperature metrology from National Measurement Institutes to those wanting to make low uncertainty temperature measurements in a range of applications.

In addition to making the best resistance measurements, the microK makes high accuracy thermocouple measurements with a voltage uncertainty of $<0.25\mu\text{V}$. The microK can be used with all standard

thermometer types including SPRTs, Industrial PRTs, Standard Thermocouples and Thermistors.

First introduced in 2006, the microK has proven use at the world's leading NIMs and many commercial laboratories.

All microK models include IEEE-488 General Purpose Interface Bus as well as RS232 and USB. The microK 70 and microK 125 also feature an Ethernet port and can be monitored and controlled across a LAN.

Performance by Design - Drift Free

"Performance by Design" was the mantra and passion behind the development of the microK. On day one a decision was made, "no tweak pots" (as to correct for flux leakage in AC Bridges), no software adjustment, no "self-calibration" but performance by design. The microK achieves its resistance ratio accuracy by design, not adjustment and is uniquely drift free.

To be clear, as a ratio bridge the microK is drift free. This is a benefit of the substitution topology used and provides one of the microK's most exciting features, it is inherently drift free.

It doesn't have compensation or adjustment circuits, it doesn't have software offsets, it doesn't self-calibrate, it never needs adjusting, never needs a service engineer. In ratio measurement it is drift free by design.

For more details read, "Using a Substitution Measurement Topology to Eliminate the Effect of Common Mode Errors in Resistance Measurements used in Temperature Metrology" available on the Isotech Website which also explains why the performance of the microK is superior to both DC potentiometric instruments and ac bridges.

Applications

- ITS-90 Fixed Point Calibration
- Comparison Calibration of Standard Thermometers
- Oceanography
- Aerospace
- Pharmaceutical
- Research

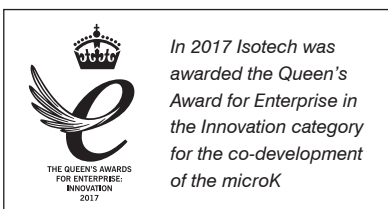

Key Features

Accuracy

Model	Ratio Accuracy ppm*	Accuracy (Whole Range) ppm
microK 70	0.017	0.07
microK 125	0.03	0.125
microK 250	0.06	0.25
microK 500	0.125	0.5

■ Resistance Thermometry

- 0.1Ω, 0.25Ω, 1Ω, 10Ω, 25.5Ω, 100Ω SPRTs
- Industrial PRTs
- Thermistors

■ Voltage Measurement

- Laboratory Standards: Platinum / Rhodium, Platinum / Gold and Base Metal, Accuracy to 0.25μV

■ Display Modes

- Numeric and Graphical
- Ratio, Resistance, Voltage, °C, °F, K

■ Stable

- ZERO drift in ratio measurement

■ Three Input Channels

- Best Practice Ready
- Expandable to 92

■ Ease of Use

- Intuitive Touch Screen Operation, Store all Standard Thermometer and Standard Resistors internally
- Log to internal memory or USB Memory Drive

■ Reliable

- 21st Century Solid State Design, no moving parts

* At Ratio: 0.95 to 1.05



Performance by Design - More Advantages

In making ratio measurements other benefits by design include:-

- **Zero Hysteresis**
There is no hysteresis effect by design
- **Zero Channel to Channel Variation**
Even with a microsKanner, as the channel expander duplicates the front end of the microK for each input rather than just being a switch box
- **Zero Temperature Coefficient**
Temperature Coefficient is 0ppm/°C, another benefit of the substitution technique. No need for warm up or stabilisation periods.
- **Complete Line Frequency Rejection**
Total rejection of 50 and 60Hz line frequency

ADC

The microK realises its superior linearity and low noise through a number of novel approaches, including a new noise reduction technique, new solid state switching, new guarding arrangements and a sophisticated substitution topology to achieve zero drift.

So perhaps it will be of no surprise to learn it also uses a new type of ADC, the concept for the core ADC technology was licensed from NPL (the UK's national standards laboratory) and operates under NPL's "Technology Applied" scheme.

It is a unique adaptation of the established sigma-delta technique, different in that it uses a 5-bit DAC in place of the 1-bit DAC in the control loop. This would not normally be feasible, since the DAC would 'carry' the full accuracy burden of the measurement. However, the microK ADC uses pulse-width-modulation (PWM) to generate the 5-bit signal thereby converting the analogue signal requirement into one of timing. In order to achieve our target of <0.03ppm, we needed to be able to produce pulses whose edges have relative timing errors of

0.3ps (about the time it takes light or electrical signals to travel 0.09mm).

For more information see "Better Accuracy in Temperature Calibration and Measurement through a New Type of Analog-to-Digital Converter" available on the Isotech Website.



Thermocouple Measurements

When used with an external 0°C cold junction reference unit (or by measuring the junction temperature with a PRT on another channel) the microK can be used for low uncertainty, precision thermocouple measurements. The microK is designed for ALL the thermometer types used in a laboratory including Standard Thermocouples. The voltage uncertainty is 0.25µV, equivalent to 0.01°C for a Platinum / Gold thermocouple at 1000°C.

When measuring the voltage from a thermocouple, it is common practice to reverse the input terminations and repeat the measurement in order to detect and/or compensate for any thermal EMFs or offsets inherent to the voltmeter instrument and its terminals. In the microK the input connections are automatically reversed immediately behind the input terminals. The user can, of course, still reverse the connections manually to gain confidence in the instrument, but it is no longer necessary to achieve low measurement uncertainty.

Keep Warm Currents

The microK includes keep-warm current sources to maintain the power in a PRT when it is not being measured, eliminating uncertainty resulting from power coefficients. Each channel, whether on the microK or a microsKanner can be individually programmed.

Zero Current Resistance

The microK was the first Bridge to have the ability to automatically compute and display the zero current resistance with no manual correction, this feature is available on the microK 70 and 125 models.

Low Noise

The new ADC, together with the low noise pre-amplifiers used in the microK, means you achieve a lower measurement uncertainty in a shorter time. See the document "Noise Performance of microK 100" available on the Isotech website.

Understanding Specifications

It can be difficult to compare the published specifications from different manufacturers as there seems no common agreement on how to present the data. As Bridges can be used in different ways, tested in different ways and have different features, confusion can easily arise. Some specifications separate accuracy, linearity and noise. Some specify a figure only at the Water Triple Point (Unity Ratio) others over ranges. At Isotech we want to present a clear picture of what can be expected from a microK and are proud that independent evaluation has shown the microK to be working to better than our published specifications.

We specify the accuracy in ppm over the whole range of the SPRT, for a microK 70 this 0.07ppm. It is given at $k=2$, 2 Sigma 95% confidence level.

We think this is a relevant, simple and transparent way of specifying the performance.

Take an example; a Primary Laboratory with a 25.5Ω SPRT and external 100Ω reference resistor. In such a situation 0.03ppm equates to $3\mu\Omega$ or 0.03mK over the whole range. If we specify the accuracy just at the water triple point (a 25.5 Ohm SPRT used with a 25 Ohm Standard Resistor); then an error of 0.03ppm is equivalent to a resistance of $0.75\mu\Omega$, for a 25.5Ω SPRT, which is equivalent in

temperature to 0.0075mK ($7.5\mu\text{K}$). Note that whilst we have specified a single value over the whole range the performance will be better close to zero and unity ratio. See table below.

Some other manufactures show figures only at the water triple point or unity gain ratio, some publish ratio accuracy valid only for a narrow operating condition. So it is important when comparing specifications to understand what is actually being claimed.

Resistance Ratio Accuracy, 95% Confidence Level (Zero Drift)	microK 70	microK 125
Ratio: 0.0 to 0.25	0.017ppm	0.03ppm
Ratio: 0.25 to 0.5	0.07ppm	0.125ppm
Ratio: 0.5 to 0.95	0.07ppm	0.125ppm
Ratio: 0.95 to 1.05	0.017ppm	0.03ppm

Ease of Calibration

Only the internal reference resistors and thermocouple voltage reference need calibrating, the procedure is both open and documented. No special equipment is needed other than a suitable voltage source (for the thermocouple side) and Standard Resistors (for internal resistors). Suitable Standard Resistors are available from Isotech.

For ratio measurement the microK is drift free, not only will it never need adjustment there is nothing to adjust, no trim pots, no software adjustments. The performance can be verified with complement and reciprocal tests using reference resistors or ideally (as with all ratio bridges) using the RBC "Ratio Bridge Calibrator" developed by D. R. White at the Measurement Standards

Laboratory, New Zealand and now licensed to and available from Isotech. See paper, "A Method for Calibrating Resistance Thermometry Bridges", D. R. White, available on the Isotech website.



< EXPANDABLE

The microK has three input channels, to allow best practice of having two standard thermometers and still have a channel free for the thermometer under test. Additional expansion channels can be added in blocks of 10 to a maximum of 90 expansion channels. The microsKanner adds no additional uncertainty and each channel is individually programmable from the touch screen. Any channel can be set for any thermometer type or for an external resistor.

Measurement Speed

The microK makes fast sub ppm measurements at a rate of <2s per channel.

Compared to an AC Bridge, the microK uses a different filtering system, rather than adjusting a bandwidth filter the number of samples per reading can be adjusted. The table gives an indication of how these compare.

AC Bandwidth Setting	Time to take single (S) measurement	Equivalent microK Samples / Reading (S)
0.02 Hz	50	25
0.1 Hz	10	5
0.5 Hz	2	1

When using a microK with a scanner it makes measurements more quickly than an AC Bridge. This is because as the AC Bridge has the input opened it goes into a different mode and can take 2 - 3 minutes to fully settle after the transitions. As the microK uses a substitution technique (it is switching at several times a second) it does not need time to recover and is much faster in multiplexing applications.

Noise Immunity

A further design goal was to ensure the microK has excellent EMC (electromagnetic compatibility) performance in terms of radiated emissions and immunity from electromagnetic interference, not just to ensure compliance to

International EMC Directives but to allow the microK to make <0.1ppm measurements in a real world environment. Extensive testing was made with long cables attached to both the inputs and PC interfaces, the requirements being that such

loads should not affect the readings. As a result the microK has far better EMC performance to older design bridges that it has replaced.

Internal and External Resistors

The instrument has internal reference resistors which allow a wide range of resistance thermometers to be used with a microK without the need for an external resistor. The use of an external or internal resistor depends both on the mode of use and the required uncertainty.

Consider an example; comparison calibration of SPRTs. In this case best practise is to directly compare the Standard Thermometer with the thermometer under test. The uncertainty is largely determined by the calibration of the Standard Thermometer and no reference resistor is needed, either external or internal.

A benefit of the microK over a traditional bridge is that by using one of the internal standards the microK can be programmed to display either the temperature or resistance of the standard probe along with the ratio of the thermometer under test to the standard. Again in this application an external resistor is not required. The value of the reference resistor is not important when comparing thermometers as long as it is stable during the period of the measurement, which is just a few seconds. Provided that the thermometers all have the same similar resistance to temperature characteristics, any change in the

reference resistor from its original calibration are negated as the shift in the thermometer under test will be equivalent to the shift in the standard.

Another example; if an NMI is using a microK to disseminate the ITS-90 temperature scale and makes absolute measurements at fixed points then a temperature controlled external standard resistor should be used in line with good laboratory practise.

For applications in between, it is necessary to consider the specification of the internal reference resistors with the required uncertainty.

CABLE POD CONNECTORS >

The gold plated connectors accept 4mm plugs, spades or bare wires. The 3/4" separation is compatible with standard 4mm to BNC adaptors, so you can use thermometers with any normal termination type. The Cable Pod™ connector system uses gold plated tellurium-copper to give the lowest possible thermal EMF and the best measurement uncertainty. The connectors have a clamping arrangement that does not rotate as the terminal is screwed down, thereby protecting the wire from mechanical damage.

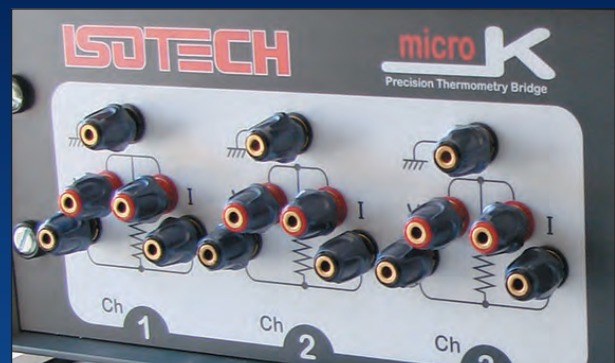

What are the advantages of the microK over conventional ratio bridges?

- Can work with thermocouples as well as resistance thermometers
- Simple Touch Screen operation with easy to use interface and data logging options
- Can connect USB Memory Stick, Keyboard, Mouse
- Built in database for all your thermometers and reference resistors
- The microK does not use tapped transformers restricting its measurement range
- Wide range of resistance, 0 - 500 k Ω
- No Moving Parts
- Displays Temperature, Resistance and Ratio
- Statistical Mode
- Chart Display
- Plug and Play Channel Expanders, control up to 92 channels from the touch screen
- No PC needed, the display can show temperature and resistance in addition to ratio
- Cost Saving

microK or AC Bridge?

The sense current in the microK's bridge circuit is a square wave AC signal. This measurement system is usually referred to as a switched DC bridge (the term AC Bridge is normally reserved for bridges that use a sinusoidal sense current). The new techniques used in the microK overcome the limitations of earlier designs, matching the performance of the best AC Bridges whilst offering a number of advantages, not least that of zero drift.

Drift

AC Bridges utilise an inductive divider, which is drift free as the turns ratio on a transformer is a constant. However, leakage flux means that AC Bridges do not inherently provide a unity ratio reading with a 1:1 turns ratio. So a correction circuit is employed to compensate, and this correction circuit is adjusted with a tweak pot. Additionally, AC bridges use many tens of potentiometers that are set up during manufacture in order to align internal filters and null out offsets. During transportation and over time these can drift out of adjustment and a specialist engineer is needed to make internal adjustments to the AC Bridge.

In comparison the microK has no potentiometers, no select on test components or software offsets -in ratio measurement it is *inherently drift free by design*.

Noise

It has been claimed that AC Bridges have the best noise performance but again the microK's innovative design sets new standards. Firstly all the microK family utilise a fast ADC that allows the sense current reversal to operate at 6-10Hz avoiding the 1/f flicker noise of many conventional switched DC systems.

Secondly, to match the performance of the most sophisticated (and expensive) AC Bridges a new technique of Parallel Analogue Processing was developed for the microK 70 and microK 125 models.

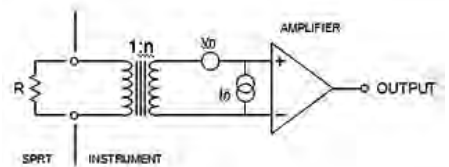

Noise Impedance Matching in AC Resistance Bridges

The best AC bridge designs use "noise impedance matching" to minimise the noise contribution of the semiconductors used in the amplifier. Since the waveforms in an AC bridge are sinusoidal, a transformer can be used at the input to the amplifier to reduce input noise at the expense of voltage noise.

This noise reduction technique can only be used with an AC resistance bridge (it cannot be used in switched DC bridges or DC current-comparator bridges) and this is one of the reasons that AC resistance bridges have historically been



< PARALLEL ANALOGUE PROCESSING

In developing the microK a new technique of Parallel Analogue Processing is used to reduce the voltage noise to a level that was only previously achievable using the best AC resistance bridges.

seen as the instrument of choice for primary standards temperature metrology.

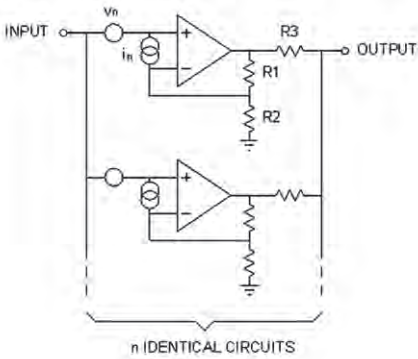

Noise Reduction by Parallel Analogue Processing

In developing the microK, a new technique of Parallel Analogue Processing was devised to reduce the voltage noise to a level that was only previously achievable using the best AC resistance bridges.

Each amplifier contributes linearly to the desired output signal. However, the noise from each amplifier contributes as the RMS (root of the mean squares), which is less than the linear summation of the signals. In a similar way to the noise impedance matching technique used in AC resistance bridges, the microK design is able to reduce voltage noise at the expense of current noise by using a number of amplifiers connected in parallel (increasing n).

Elimination of Thermal EMF

Like an AC Bridge, the microK eliminates the effect of thermal EMFs (EMFs generated as the result of dissimilar metals and temperature gradients) by taking two measurements and reversing the current between them.

The process of current reversal and averaging, together with true 4-wire resistance measurement has the effect of eliminating thermal EMF and of ensuring an intrinsically stable zero with time and temperature.

Line Frequency Rejection

As the microK range of instruments uses digital filters these provide 100% or complete rejection of 50Hz and 60Hz. Other instruments may use analogue filters which provide finite rejection but the digital filters used in microK's provide complete rejection.



THREE INPUT CHANNELS >

Best practice guidelines recommend the use of two reference thermometers for calibrations. That is why we have included three channels in the microK, enabling you to achieve best practice without having to buy additional and costly multiplexers. Other benefits are when calibrating SPRTs in Fixed Point Cells, the third channel can be connected to a monitor SPRT to check the standard resistor. When intercomparing ITS-90 cells two SPRTs are exchanged to get accurate temperature differences - the third channel allows the two SPRTs to be compared to a reference resistor.

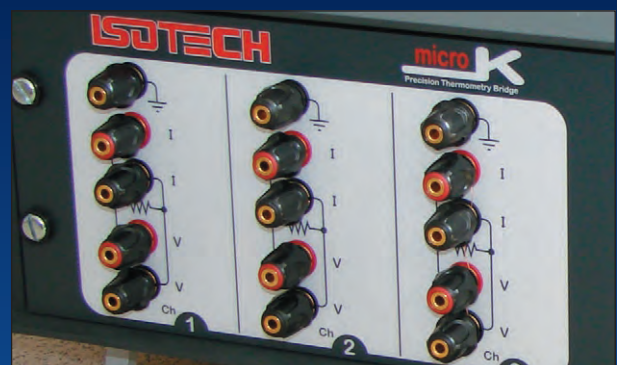

microKanner: Channel Expander

The microKanner can be used with any member of the microK family to add further channels, up to a maximum of 90 expansion channels.

Easy to Use: The use of plug-and-play technology means that the extra channels appear automatically on your microK bridge when connected to a microKanner. You can configure the new input channels in exactly the same way as any of the microK's existing inputs (through the microK's touch screen or a PC, via an RS232 connection). You just plug in a microKanner and immediately gain the benefit of the additional channels, making this the easiest channel expansion system of its type.

Accurate: The microKanner replicates the input system of the microK bridge for all 10 of its input channels. Measurements made with a microKanner are therefore to the same accuracy as the microK bridge it is connected to. By adding further scanners the microK system can be expanded to 92 channels without losing measurement performance.

Versatile: Like the microK bridge, the microKanner works with PRTs, thermocouples and thermistors giving you unparalleled flexibility.

Keep-Warm Currents: The microKanner has 10 individually programmable keep-warm current sources to maintain the power in PRTs when they are not being measured, eliminating uncertainty caused by power coefficients.

Cable Pod™ Connector System: The connectors accept 4mm plugs, spades or bare wires. The standard



3/4" separation is compatible with standard 4mm to BNC adaptors, so you can use thermometers with any standard termination type. The Cable Pod™ connector system uses gold-plated, tellurium-copper to give the lowest possible thermal EMF and the best measurement uncertainty.

Reliable: Like the microK, the microKanner uses the latest semiconductor technology for channel selection and signal routing. This completely solid-state design therefore provides the highest possible reliability.

Model	microKanner
Channels	10
Keep-Warm Currents	0-10mA ±0.4% of value, ±7µA, resolution 2.5µA
Input connectors	Cable Pod™ connector accepting: 4mm plugs, spades or bare wires
Contact material	Gold plated tellurium copper
Interface	RS232 (9600 baud)
Operating conditions	15-30°C / 50-85°F, 10-90% RH (for full specification) 0-50°C / 32-120°C, 0-99% RH (operational)
Power	88-264V (RMS), 47-63Hz (Universal) 10W maximum, 1.2A (RMS) maximum
Size	520mm x 166mm x 300mm / 20.5" x 6.6" x 11.9" (W x D x H)
Weight	12.6kg / 28lb



< RELIABLE

Before the microK, instruments with this level of performance had to use mechanical relays. The microK breaks the mould by using the latest semiconductor devices to provide a completely solid state solution. To reduce the component count, high density silicon integration technology is used (FPGA). If you have ever seen inside another instrument in this performance class you may have been concerned about long term reliability and servicing cost. Compare this with the inside of the microK

microKanner

- **Performance** - zero uncertainty contribution
- **Flexibility** - supports all sensor types (PRTs, thermocouples & thermistors)
- **Keep-warm currents for PRTs** - individually programmable
- **Ease of use** - plug-and-play... new channels added by the microKanner just appear in the existing operator interface on the microK
- **Input channels** - up to 90 expansion channels
- **Reliability** - completely solid-state (no relays)



WEB LINKS >

- Using a Substitution Measurement Topology to Eliminate the Effect of Common Mode Errors in Resistance Measurements used in Temperature Metrology
- Better Accuracy in Temperature Calibration and Measurement through a New Type of Analog-to-Digital Converter
- Noise Performance of microK 100
- A Method for Calibrating Resistance Thermometry Bridges, D. R. White



microK GOLD

We are now able to offer a microK with enhanced performance to <30ppb (whole range, 0 to unity) and an unmatched performance promise and warranty...

This unique package is called "microK GOLD".

Unique Promise - Performance Guaranteed

We guarantee the 30ppb performance and provide evidence by calibrating the microK with an Automatic Ratio Bridge Calibrator, A-RBC. What is more, you can choose to return the bridge for validation of the ratio accuracy in year two and three with no charge for calibration, you pay only for the carriage.

No other company makes this commitment - we challenge you to find any other company to report ratio accuracy, measured with the RBC and who guarantee that for three years.

Confidence

As well as the performance promise we are including an extended three year warranty. Thermometry bridges at this level require a large investment; choose Isotech for the best performance and confidence.

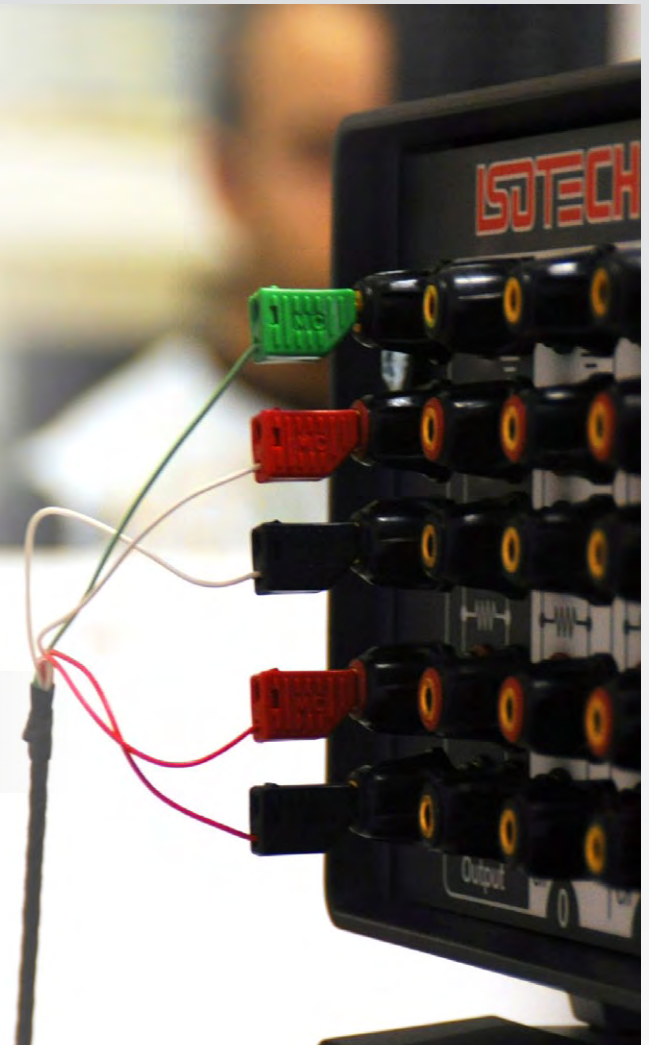

microK Specifications (Specifications are subject to change without prior notice)

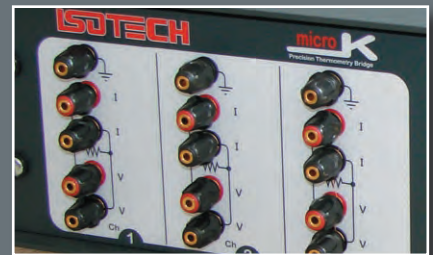

Parameter	microK GOLD
Accuracy Whole Range (SPRT $R_0 \geq 2.5\Omega$) ^[1]	0.03ppm / 30ppb
Resolution	0.001mK
Resolution Voltage	10nV
Stability	0ppm/yr ^[3]
TC (resistance ratio) ^[4]	0ppm/°C ^[3]
Resistance Range	0 - 100 kΩ
Voltage Range (Thermocouple)	±125mV
Internal Resistance Standards	25, 100, 400Ω
Internal Standard Resistor Stability	TCR <0.05ppm/°C Annual Stability <2ppm/year
Interfaces	RS232, GPIB & USB & Ethernet
Power	25W maximum, 1.5A (RMS) maximum
Weight	13.3kg

microK Universal Specifications

Accuracy - Thermocouples	Voltage uncertainty: Range 0-20mV 250nV. Equivalent to 0.01°C for Gold Platinum thermocouples at 1000 °C	Expandable	Add up to 90 expansion channels
Measurement Time (Per Channel)	Resistance: <2s Voltage: <1s	Probes Supported	PRT's, Thermistors & Thermocouples
Temperature Conversions	PRTs: ITS-90, Callendar-van Dusen. Thermocouples: IEC584-1 1995 (B, E, J, K, N, R, S, T), L, Pt / Pd and gold-platinum. Thermistors: Steinhart-Hart	Units	Ratio, V, Ω, °C, °F, K
Cable Length	Limited to 10Ω per core and 10nF shunt capacitance (equivalent to 100m of RG58 coaxial cable)	Switching Technology	Solid state
Input Connectors	Cable Pod™ connector accepting: 4mm plugs, spades or bare wires Contact material: gold plated tellurium copper	Sensor Current	0 – 10mA in 3 Ranges 0 – 0.1mA ±0.4% Value ±70nA (Resolution 28 nA) 0.1 – 1mA ±0.4% Value ±0.7µA (Resolution 280nA) 1– 10mA ±0.4% Value ±7µA (Resolution 2.8 µA)
Interfaces	RS232 (9600 baud), USB (1.1) - host, IEEE-488 GPIB	Keep Warm Current	Adjustable 0-10mA Each Channel Adjustable 0-10mA ±0.4% Value ±7µA (Resolution 2.8 µA)
Ratio Range	Unlimited	Internal Data Storage	2Gb: For > 4 years storage (Timed Stamped Measurements)
Display	163mm / 6.4" VGA (640 x 480) Colour TFT LCD	Operating Conditions	For Full Specification: 15 - 30°C 10 - 80% RH Operational: 0 - 40°C 0 - 95% RH
Channels	3	Supply	88-264 Vac, 47-63Hz
Cold Junction Mode	External ice point and remote with PRT	Size W x D x H	520mm x 166mm x 300mm / 20.5" x 6.6" x 11.9" (19" Rack Mountable)

microK Specifications (Specifications are subject to change without prior notice)



Parameter	microK 70	microK 125	microK 250	microK 500
Accuracy Whole Range (SPRT $R_o \geq 2.5\Omega$) ^[1]	0.07ppm	0.125ppm	0.25ppm	0.5ppm
Accuracy Ratio 0.95 to 1.05 ^[2]	0.017ppm	0.03ppm	0.06ppm	0.125ppm
Equivalent Temperature Accuracy ^[2]	0.017mK	0.03mK	0.06mK	0.125mK
Resolution	0.001mK	0.001mK	0.01mK	0.01mK
Resolution Voltage	10nV	10nV	10nV	10nV
Stability	0ppm/yr ^[3]	0ppm/yr ^[3]	0ppm/yr ^[3]	0ppm/yr ^[3]
TC (resistance ratio) ^[4]	0ppm/°C ^[3]	0ppm/°C ^[3]	0ppm/°C ^[3]	0ppm/°C ^[3]
Resistance Range	0 - 100 kΩ	0 - 100 kΩ	0 - 500 kΩ	0 - 500 kΩ
Voltage Range (Thermocouple)	± 125mV	± 125mV	± 125mV	± 125mV
Internal Resistance Standards	25, 100, 400Ω	25, 100, 400Ω	1, 10, 25, 100, 400Ω	1, 10, 25, 100, 400Ω
Internal Standard Resistor Stability	TCR <0.05ppm/°C Annual Stability <2ppm/year		1, 10Ω <0.6ppm/°C <5ppm/year 25,100,400 <0.3ppm/°C <5ppm/year	
Interfaces	RS232, GPIB & USB & Ethernet		RS232, GPIB, USB	
Power	25W maximum, 1.5A (RMS) maximum		20W maximum, 1.5A (RMS) maximum	
Weight	13.3kg	13.3kg	12.4kg	12.4kg

Notes:

- Over whole range of SPRT, -200°C to 962°C. For $R_o=0.25\Omega$ increased by a factor of 2.5
- E.g.: 25Ω SPRT with 25Ω standard resistor at water triple point or with direct comparison of similar SPRTs.
- The microK uses a "substitution technique" in which the Device-Under-Test and the Reference are successively switched into the same position in the measuring circuit. This means that the stability of resistance ratio measurements is immeasurably small.
- Using external reference resistors.

Resistance Bridge Calibrator (RBC)



Manual and Automatic Models

Isotech have a unique solution to measure the performance of resistance bridges - the RBC. It is used to verify the performance of all microK models. Developed by D. R. White at the Measurement Standard Laboratory of New Zealand, the RBC allows bridge performance to be fully evaluated. Isotech has an exclusive license from MSL to manufacture and supply the RBC.

Confidence

RBC testing of microK establishes both confidence and evidence of the microK's performance. When NMIs have used the RBC to evaluate other bridges many have been found to be out of specification or have 'small but significant' faults.

The RBC can generate 70 ratios (including complements) combining reciprocal and linearity checks. Neither the exact values or frequency dependence of the base resistors need to be known.

The result is a system that can evaluate both AC and DC bridges with an accuracy to 10ppb at 100 Ohms.

The supplied software produces full reports

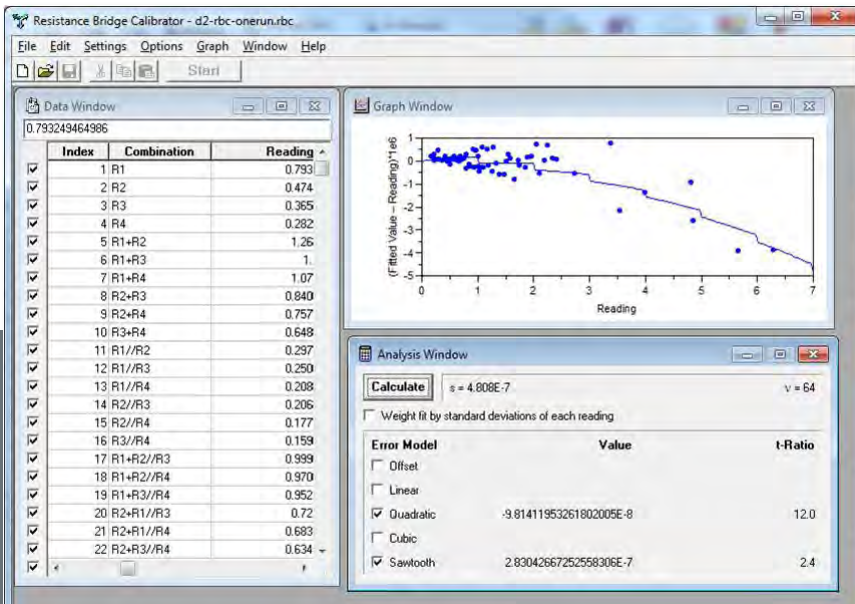

For further information, see our website:
<http://www.isotech.co.uk/rbc>

The RBC has allowed both Isotech and leading NMIs to validate microK performance, it has given metrologists evidence of actual performance and contributed to the outstanding success of the microK bridge.

Automatic vs Manual

The manual model is operated from switches and the data manually entered into the software for analysis and reporting.

The new automatic model is operated from a PC via a USB connection. There are drivers for the Isotech microK, milliK and AC and DC bridges from other manufactures that allow for fully automatic and unattended calibration of commonly used thermometry bridges. The software design allows for

new drivers to be created as DLLs and we expect to support a growing number of bridges, check the website for full details The RBC 100A / 400A benefits not only from automatic operation but with changes to the internal circuitry to increase the accuracy and they can be immersed in oil to allow temperature control.

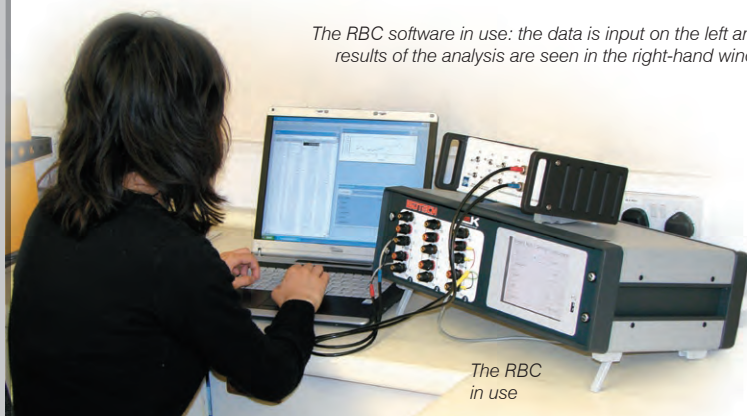

The RBC software in use: the data is input on the left and the results of the analysis are seen in the right-hand windows.

The RBC in use

Can you trust your bridge?

In the paper "A Method for Calibrating Resistance Thermometry Bridges" D. R. White evaluated 38 Bridges. He found significant faults with 15% of those tested, but "like the walking wounded" they continued to provide a plausible reading.

The RBC allows easy verification and calibration of your bridge ensuring measurements are accurate and traceable, use it to Restore Bridge Confidence.

MANUAL Specifications



Accuracy:	<0.1ppm at 100Ω (For DC and AC to 400 Hz)
Temperature Coefficient:	< ±0.3 ppm/ °C.
Maximum Sensing current:	RBC100M: 10mA RBC400M: 5mA
Resistance range:	RBC100M: 16Ω to 127Ω RBC400M: 43Ω to 346Ω
Power supply:	None - the RBC is completely passive
Connections:	Four-terminal coaxial using separate BNC for the current and voltage leads
Case Dimensions:	Width 215mm Height 105mm Depth 200mm (2U height by half rack width)
Weight:	2.5 kg

AUTOMATIC Specifications



Accuracy:	<0.01ppm at 100Ω (For DC and AC to 400 Hz. When RBC is temperature controlled)
Temperature Coefficient:	< ±0.3 ppm/ °C
Maximum Sensing current:	RBC100A: 5mA RBC400A: 3mA
Resistance range:	RBC100A: 16Ω to 127Ω RBC400A: 43Ω to 346Ω
Power supply:	5V, via the USB cable. Idle current typically less than 5mA, switching currents less than 200mA.
Connections:	Signal: Five-terminal guarded dc, spade lugs. Digital control: USB.
Case Dimensions:	Diameter 88mm Height 140mm Identical to Tinsley type standard resistors.
Weight:	1.25 kg

Software

- Tabular and graphical representation of data
- Least-squares fit to determine model of bridge error
- Tabular summary of data and results
- Print calibration report

Compatible with Microsoft Windows XP to Windows 10 platforms



Winner of the prestigious
QUEEN'S AWARD FOR ENTERPRISE - INNOVATION

Calibration Solutions for

Request our catalogues



**Primary & Secondary
Laboratories**



**Temperature Sensors
Infrared Thermometers
Thermocouple Referencing Systems**



ISOTECH



The Source for Calibration Professionals

Telephone: +44 (0)1704 543830

Fax: +44 (0)1704 544799 Email: info@isotech.co.uk

Isothermal Technology Limited

Pine Grove, Southport, Merseyside PR9 9AG England

www.isotech.co.uk